

EasyVEC® C4 micro-watt

EasyVEC® C4 micro-watt 3000

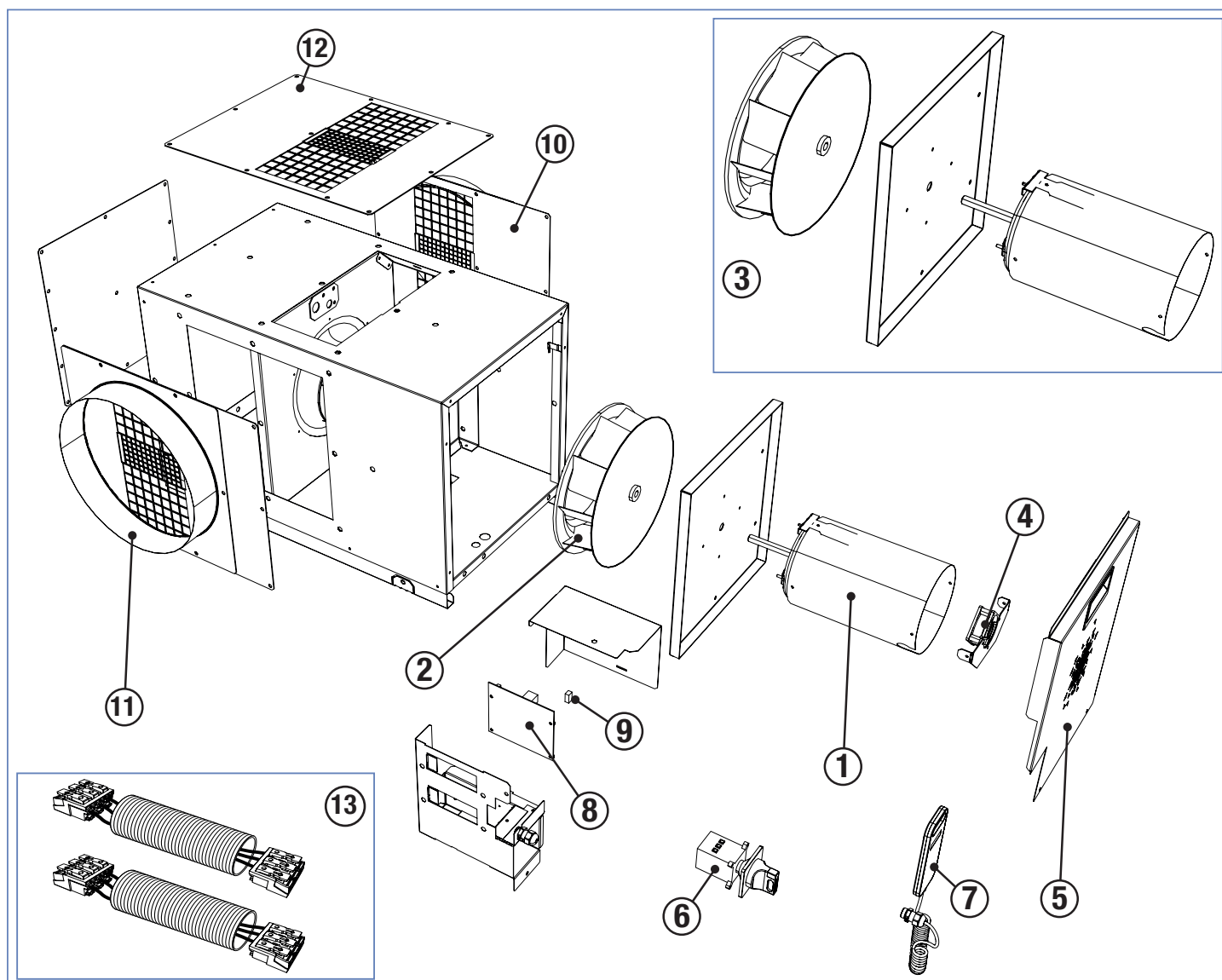

No - Nr	11034806 - 3000 IP avec choix d'options	11034806 - 3000 arrangement 1 IP	11034832 - 3000 arrangement 2 IP
1	11125691	11125691	11125691
2	11125670	11125670	11125670
3	11124663	11124663	11124663
4	11125895	11125895	11125895
5	11125369	11125369	11125369
6	11125876	11125876	11125876
7	11125928	11125928	11125928
8	11125927	11125927	11125927
9	11034400	11034400	11034400
10	11034454	11034454	11034454
	11034458	11034458	11034458
11	11034444	11034444	11034444
12	11034464	11034464	11034464
	11034468	11034468	11034468
13	11125689	11125689	11125689

EasyVEC® C4 micro-watt

Key / Légende / Legende / Verklaring / Leyenda / Leggenda

	FR	EN	DE	NL	ES	IT
1	Moteur	Motor	Motor	Motor	Motor	Motore
2	Roue	Impeller	Rad	Rotor	Rueda	Ruota
3	Sous-ensemble moteur + roue + paroi support	Sub-assembly: motor, impeller, mounting plate	Untergruppe Motor + Rad + Haltewand	Subset motor+rotor+ steunplaat	Subconjunto motor + rueda + pared soporte	Sottoinsieme motore + ruota + supporto a parete
4	Moto-ventilateur de refroidissement additionnel	Additional cooling fan unit	Zusätzliches Motorkühlgebläse	Extra elektrische koelventilator	Motoventilador de refrigeración adicional	Motoventilatore di raffreddamento addizionale
5	Porte y compris poignée	Door, includes handle	Tür inklusive Griff	Deur met handvat	Puerta, incluyendo empuñadura	Porta comprendente maniglia
6	Interrupteur	Switch	Schalter	Aan/uit-schakelaar	Interrupctor	Interruttore
7	Télécommande	Remote control	Fernbedienung	Afstandsbediening	Telecomando	Telecomando
8	Carte électronique	PCB	Elektronikkarte	Elektronische printplaat	Tarjeta electrónica	Scheda elettronica
9	Module Modbus	Modbus module	Modul Modbus	Modbus-module	Módulo Modbus	Modulo Modbus
10	Grille	Grille	Gitter	Rooster	Rejilla	Griglia
	Grille (modèles isolés)	Grille (insulated models)	Gitter (isolierte Modelle)	Rooster (modellen met isolatie)	Rejilla (modelos aislados)	Griglia (modelli isolati)
11	Piquage	Branch	Messanschluss	Leidingaansluiting	Derivación	Raccordo di aspirazione
	Piquage (modèles isolés)	Branch (insulated models)	Messanschluss (isolierte Modelle)	Leidingaansluiting (modellen met isolatie)	Derivación (modelos aislados)	Raccordo di aspirazione (modelli isolati)
12	Bouchon	Plug	Stopfen	Dop	Tapón	Tappo
	Bouchon (modèles isolés)	Plug (insulated models)	Stopfen (isolierte Modelle)	Dop (modellen met isolatie)	Tapón (modelos aislados)	Tappo (modelli isolati)
13	Kit faisceaux	Wiring kit	Kabelbaum-Kit	Draadbundelset	Kit haces	Kit fasci